



fischer[®]technik[®] u-t-S



















Anleitung zum Einordnen und Handhabung der
Statik-Bauelemente.

Introduction to storage and use of the
static building elements.

Conseils pour le rangement et la manipulation
des éléments de construction statique.

Handleiding voor het samenvoegen en de
toepassing van de statika-bouwelementen.

Stückliste ut S

	Art-Nr.	Stückzahl	Bezeichnung		Art-Nr.	Stückzahl	Bezeichnung
	4 363211	3	Platte 180×90 plate 180×90 plaque 180×90 plaat 180×90		4 363071	8	Flachstück 120 flat strut 120 raccord plat 120 vlakke steun 120
	4 357741	1	Aufnahmeplatte für X-Streben collector plate for X-struts plaque de rangement pour contrefiches-X opneemplaat voor X-spanten		4 358001	1	S-Griff key-bolt fool poignée S S-greep
	4 357731	1	Aufnahmeplatte für I-Streben collector plate for I-struts plaque de rangement pour contrefiches-I opneemplaat voor I-spanten		4 363201	8	X-Strebe 169,6 X-strut 169,6 contrefiche-X 169,6 X-spant 169,6
	3 365181	1	Kassette case cassette cassette		4 363191	8	X-Strebe 127,2 X-strut 127,2 contrefiche-X 127,2 X-spant 127,2
	4 357721	6	Aufnahmestreifen 120 collector stripe 120 bande de rangement 120 opneemstrook 120		4 363181	16	X-Strebe 106 X-strut 106 contrefiche-X 106 X-spant 106
	4 357711	2	Aufnahmestreifen 60 collector stripe 60 bande de rangement 60 opneemstrook 60		4 363161	16	X-Strebe 63,6 X-strut 63,6 contrefiche-X 63,6 X-spant 63,6
	4 357981	4	Aufnahmestreifen 8×60 collector stripe 8×60 bande de rangement 8×60 opneemstrook 8×60		4 363151	16	X-Strebe 42,4 X-strut 42,4 contrefiche-X 42,4 X-spant 42,4
	4 363031	12	Winkelträger 120 angle girder 120 cornière 120 hoekdraagsteun 120		4 363141	8	I-Strebe 120 I-strut 120 contrefiche-I 120 I-spant 120
	4 363051	8	Flachträger 120 flat girder 120 cornière plate 120 vlakke draagsteun 120		4 363131	8	I-Strebe 90 I-strut 90 contrefiche-I 90 I-spant 90
					4 363121	16	I-Strebe 75 I-strut 75 contrefiche-I 75 I-spant 75

Stückliste ut S





	Art.-Nr.	Stückzahl	Bezeichnung		Art.-Nr.	Stückzahl	Bezeichnung
	4 363101	16	I-Strebe 45 I-strut 45 contrefiche-I 45 I-spant 45		4 363251	8	Eckknotenplatte corner connector plate gousset de coin hoekknooplaaf
	4 363091	16	I-Strebe 30 I-strut 30 contrefiche-I 30 I-spant 30		4 363271	12	Lasche 21,3 fish-plate 21,3 couvre-joint 21,3 rechtverbindungsstuk 21,3
	4 363021	8	Winkelträger 60 angle girder 60 cornière 60 hoekdraagsteun 60		4 363261	12	Lasche 15 fish-plate 15 couvre-joint 15 rechtverbindungsstuk 15
	4 363011	8	Winkelträger 30 angle girder 30 cornière 30 hoekdraagsteun 30		4 363291	8	Scharnier hinge Nr. 1 charnière No. 1 scharnier Nr. 1
	4 363001	8	Winkelträger 15 angle girder 15 cornière 15 hoekdraagsteun 15		4 357381	8	Winkellasche angle fish-plate couvre-joint d'angle hoekverbindungsstuk
	4 363041	8	Winkelträger 15 mit 2 Zapfen Angle girder 15 with 2 lugs cornière 15 avec 2 tenons hoekdraagsteun 15 met 2 kappen (pennen)		4 363231	108	S-Riegel 4 key-bolt 4 rivet 4 grendel 4
	4 363081	6	Bogenstück 60° curved strut, small radius raccord courbe, petit rayon boogstuk, kleine radius		4 363241	16	S-Riegel 6 key-bolt 6 rivet 6 grendel 6
	4 363061	6	Bogenstück 30° curved strut, large radius raccord courbe, grand rayon boogstuk, grote radius		4 364571	12	S-Riegel 8 key-bolt 8 rivet 8 grendel 8
	4 357971	8	Doppelknotenplatte dual connector plate gousset double dubbele knooplaaf		4 364581	8	Prüfriegel control bolt rivet de contrôle controlegrendel
	4 363221	6	Kreuzknotenplatte nodal connector plate gousset de croisement kruisknooplaaf		4 363341	24	Riegelscheibe blocking washer disque d'arrêt grendelschijf

Abb. 1-4 Zusammenfügen der Winkelträger
Abb. 5-11 Verbinden der Winkelträger mit Bausteinen des u-t 1

Pict. 1-4 Joining the angle girders.
Pict. 5-11 Connecting the angle girders with building blocks from the u-t 1.

Fig. 1-4 Assemblage des cornières.
Fig. 5-11 Liaison entre cornières et éléments du u-t 1.

Afb. 1-4 Het aan elkaar bevestigen van de hoekdraagsteunen.
Afb. 5-11 De verbinding van de hoekdraagsteunen met bouwstenen uit de u-t 1.

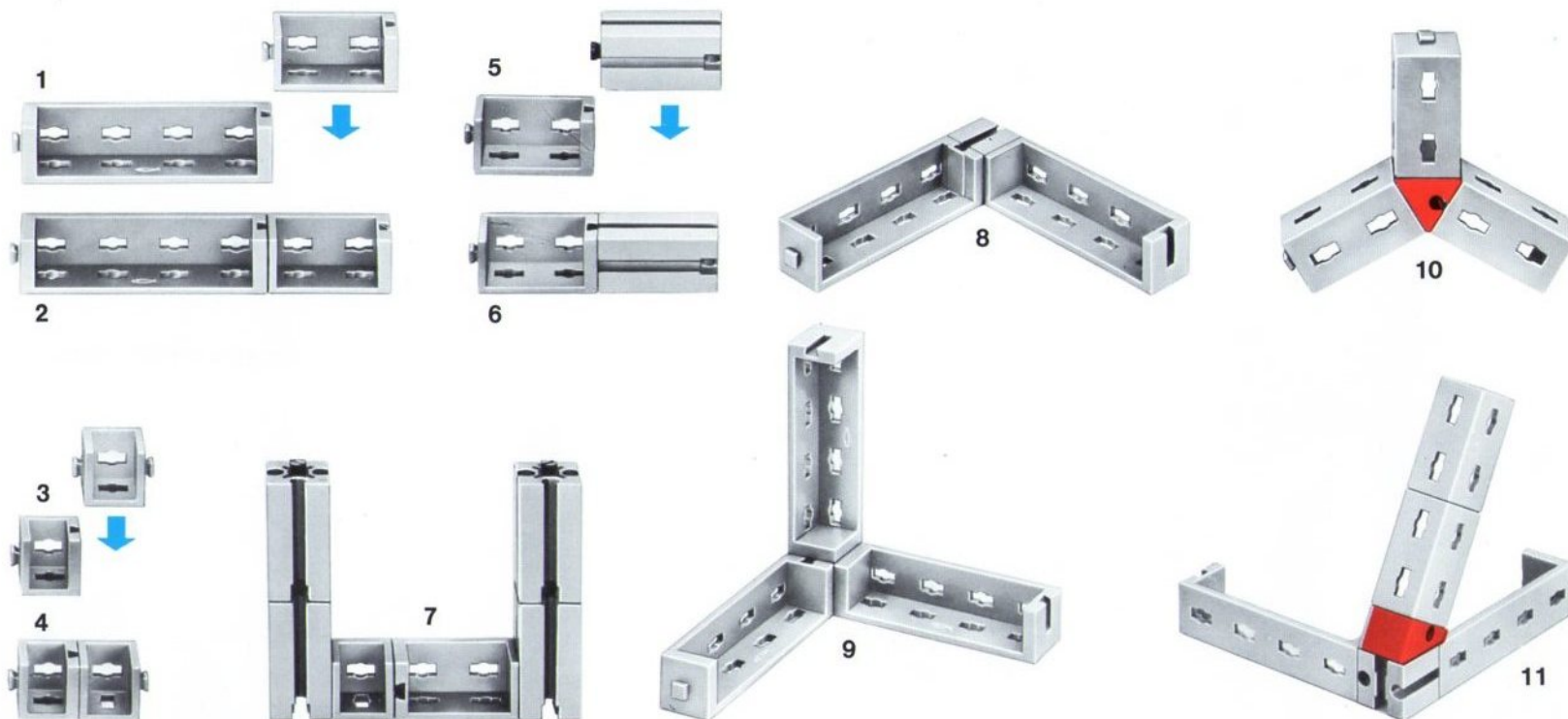

- Abb. 12, 13 Gelenkstein (aus u-t 1) und Scharnier in Verbindung mit Winkelträgern.
- Abb. 14–16 Zusammenfügen des Flachträgers mit Flachstück und Bogenstück.
- Abb. 17, 18 Verbinden von Winkelträgern mit Hilfe der Eckknotenplatte.
- Pict. 12, 13 Elbow joint (from the u-t 1) and hinge, in connection with angle girders.
- Pict. 14–16 Connecting the flat girders with flat and curved struts.
- Pict. 17, 18 Connecting angle girders by means of corner connector plate.

- Fig. 12, 13 Pierre articulée (du u-t 1) et charnière pouvant relier deux cornières.
- Fig. 14–16 Assemblage de la cornière plate avec un raccord plat et un raccord courbé.
- Fig. 17, 18 Liaison entre cornières avec le gousset de coin.
- Afb. 12, 13 Scharniersteen (uit de u-t 1) met scharnier in combinatie met hoekdraagsteunen.
- Afb. 14–16 Samenvoegen van de vlakke draagsteun met vlakke steun en boogstuk.
- Afb. 17, 18 Verbinding van hoekdraagsteunen met behulp van de hoekknoopplaat.

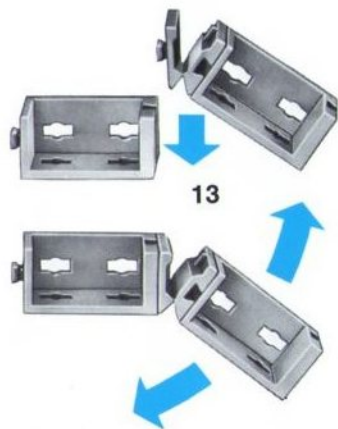
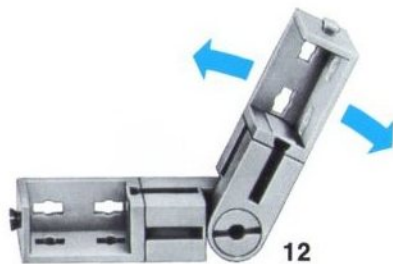

14



15

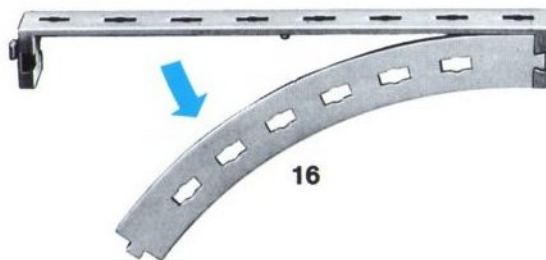

16



17



18

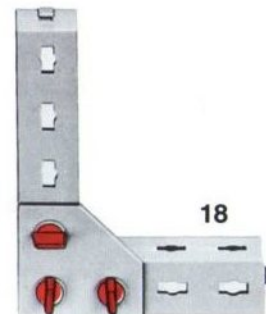

- Abb. 19, 20 S-Riegel 4 zur Verbindung von Winkelträgern.
 Abb. 21 Befestigen von Streben durch Einschieben des S-Riegels 4 in die Nut der Bausteine 30.
 Abb. 22-24 Befestigen von Streben mit dem S-Riegel 4.
 Abb. 25, 26 Verwendung des S-Riegels 6 und S-Riegels 8.
 Abb. 27 Herstellen eines Gelenks durch S-Riegel 6 und Riegelscheibe.

- Fig 19, 20 Rivet S 4 pour liaisons de cornières.
 Fig. 21 Fixation de contrefiches en insérant le rivet S 4 dans la rainure des pierres de construction 30.
 Fig. 22-24 Utilisation du rivet S 4.
 Fig. 25 26 Utilisation du rivet S 6 et du rivet S 8.
 Fig. 27 Réalisation d'une articulation avec le rivet S 6 et un disque d'arrêt.

- Pict. 19, 20 Key-bolt 4 for connecting angle girders.
 Pict. 21 Securing struts by inserting key-bolt 4 in the groove of the building blocks 30.
 Pict. 22-24 Fastening struts with key-bolt 4.
 Pict. 25, 26 Use of key-bolt 6 and key-bolt 8.
 Pict. 27 Making a joint with key-bolt 6 and blocking washer.

- Afb. 19, 20 S-grendel 4 ter verbinding van hoekdraagsteunen.
 Afb. 21 Het bevestigen van spanten door inschuiven van de S-grendel 4 in de groef van de bouwstenen 30.
 Afb. 22-24 Bevestiging van spanten met de S-grendel 4.
 Afb. 25, 26 Toepassing van S-grendel 6 en S-grendel 8.
 Afb. 27 Het maken van een scharnier door S-grendel 6 en grendelschijf.



19

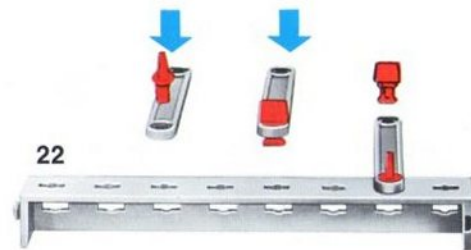

22



20



23



21



24



25



26

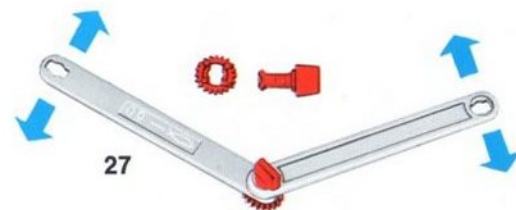

27

Zuerst die Bauelemente als untere Lage einordnen. (Winkelträger werden mit den Zapfen in die Schlitzte der roten Aufnahmestreifen gesteckt.)

First arrange the building elements as a lower layer. (Angle girders are stuck with the pivots in the slits of the red receptacle strips).

Ranger d'abord les éléments du fond de la boîte. (Les cornières sont assemblées sur la bande de rangement.)

Eerst de bouwelementen als onderste laag rangschikken. (Hoekdraagsteunen worden met de pen in de gleuf van de rode opnemingsstrook gestoken.)

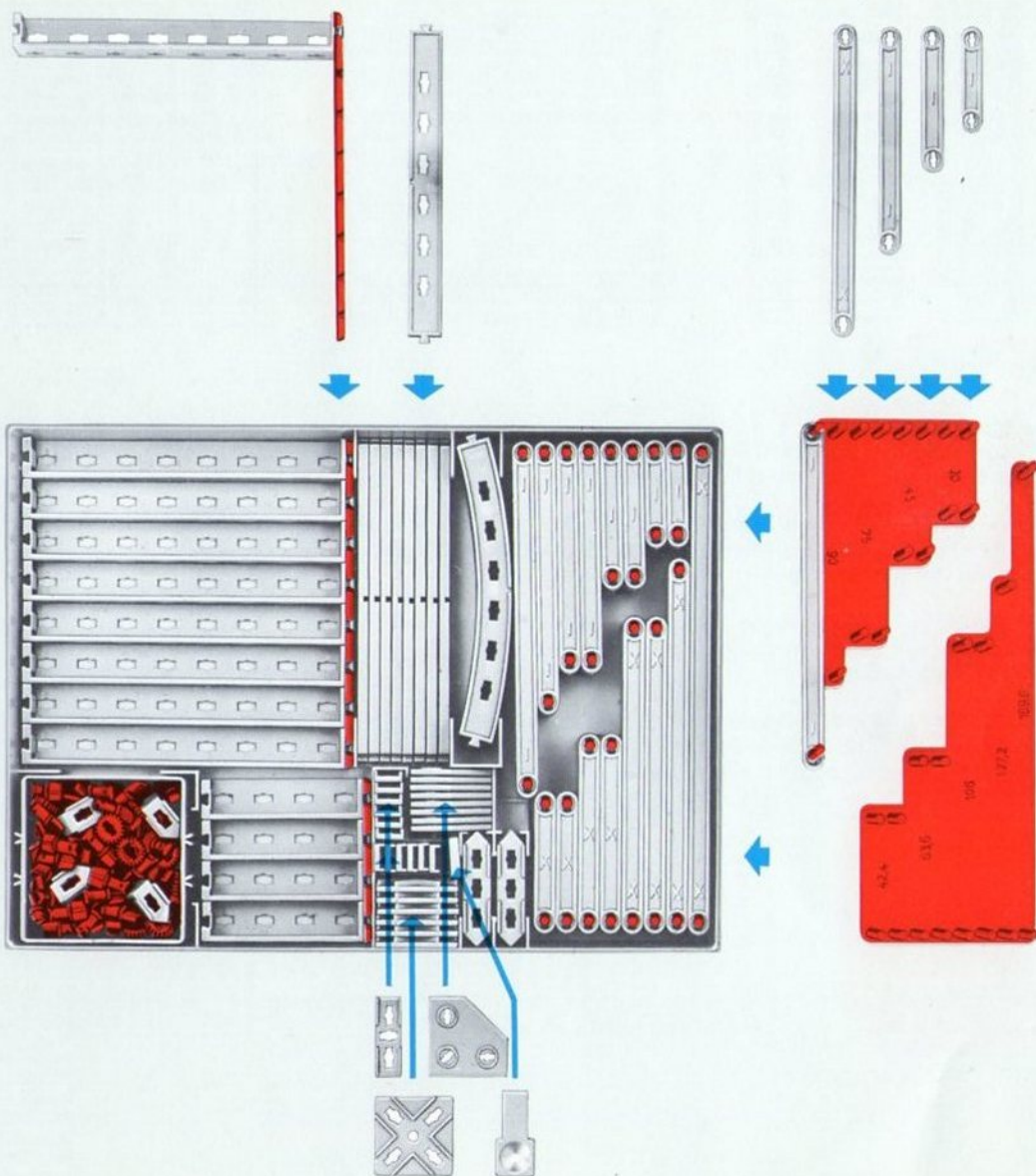
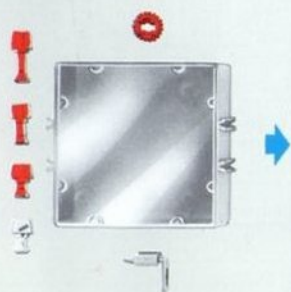

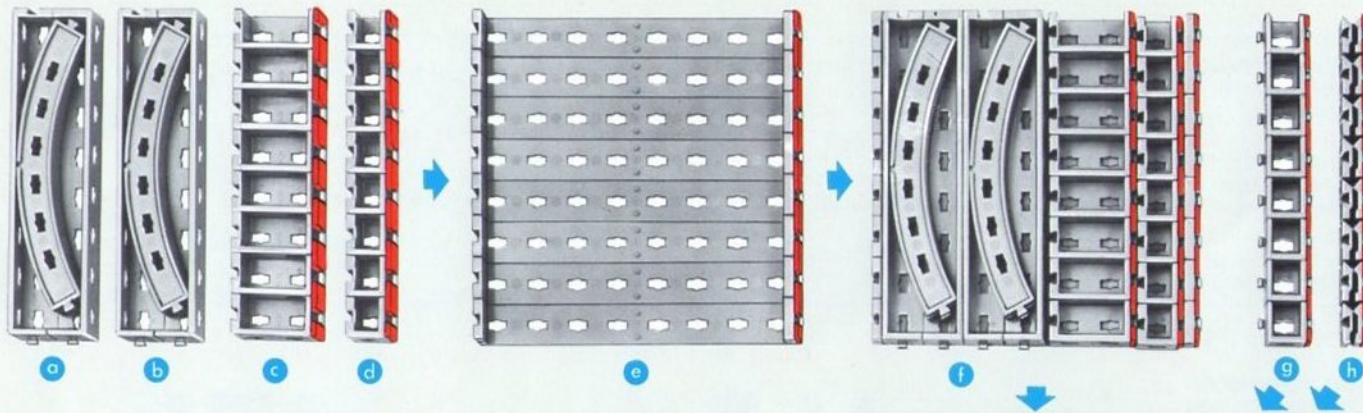

Sodann die Montagegruppe a, b, c, d zusammenstellen und in die 8 Flachträger e einlegen. Jetzt das gesamte Paket f auf die Winkelträger 120 und die Montagegruppe g und h auf die 8 Flachstücke legen.

Then put together the assembly group a, b, c, d and lay in the 8 flat girders e. Next the whole of pack f on the angle girders 120, then lay the assembly group g and h on the 8 flat struts.

Constituer les groupes a, b, c, d et les introduire dans les cornières plates e. L'ensemble du paquet f est posé sur les cornières 120 et les groupes g et h posés sur les 8 bandes plates.

Daarna de montagedelen a, b, c, d samenstellen en samen in de 8 vlakke draagsteunen e inleggen. Nu het hele pakket f op de hoekdraagsteunen 120 en de montagegroep g en h op de 8 vlakke stukken leggen.

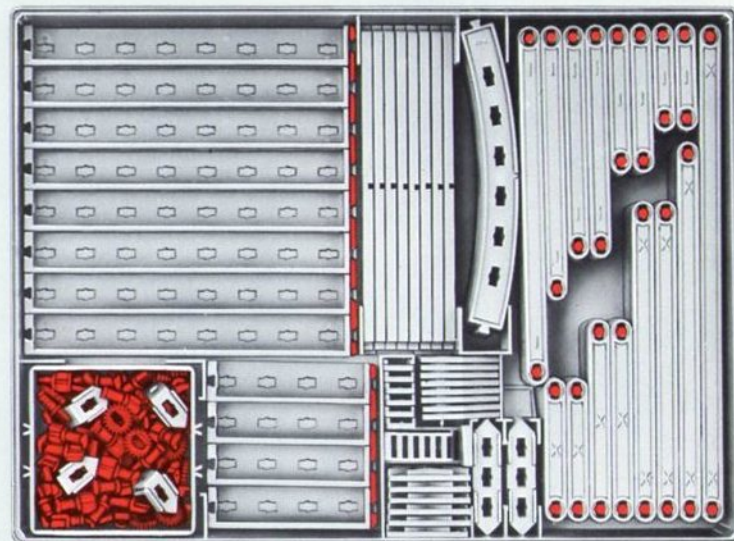

Danach die 3 Platten 180 einordnen und zuletzt die 8 Doppelknotenplatten (jeweils 2 durch Aufnahmestreifen verbunden) in die Zwischenräume legen. (Siehe auch Deckelrückseite.)

Next put away the 3 plates 180 and finally lay the double connector plates (two in each receptacle strip) in the spaces between them. (See also reverse side of kit cover.)

Ranger ensuite les 3 plaques 180 et pour finir les 8 goussets doubles (groupés 2 par 2 sur une bande de rangement) sont placés dans les espaces libres. (Voir face interne du couvercle.)

Verder de 3 platen 180 rangschikken en tenslotte de 8 dubbele knoopplaten (2 aan 2 door opnemingsstrook verbonden) in de tussenruimten leggen. (Zie ook achterkant van het deksel.)

